

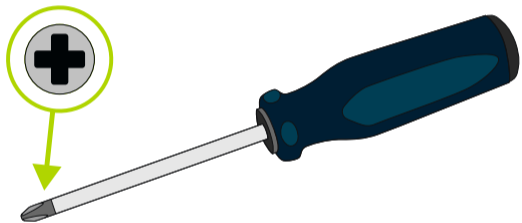

Danapad V3



www.danalock.com



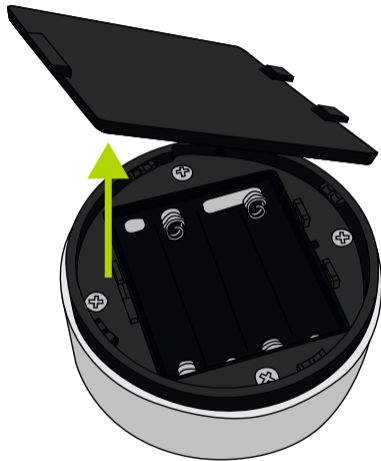
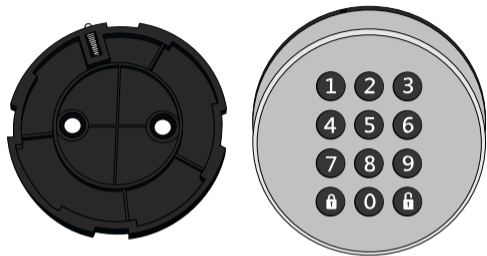

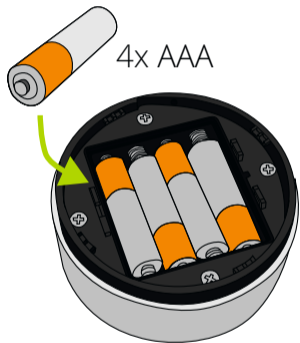

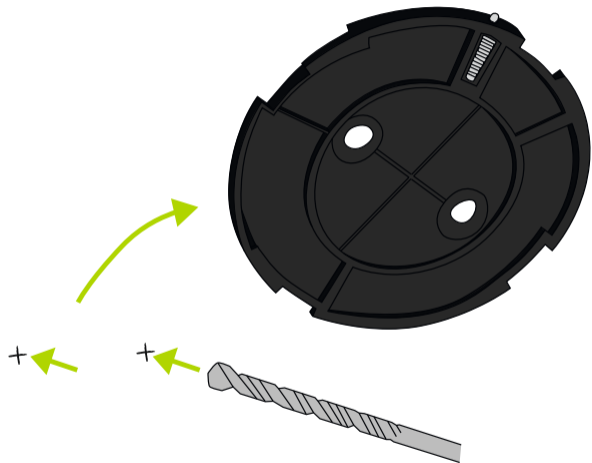
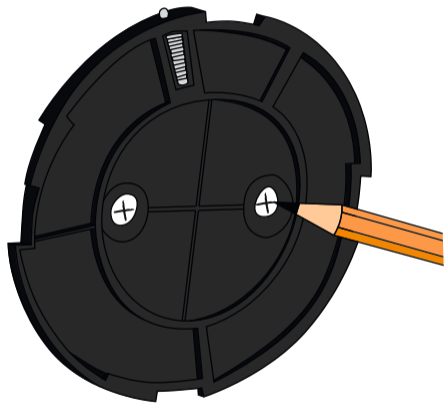

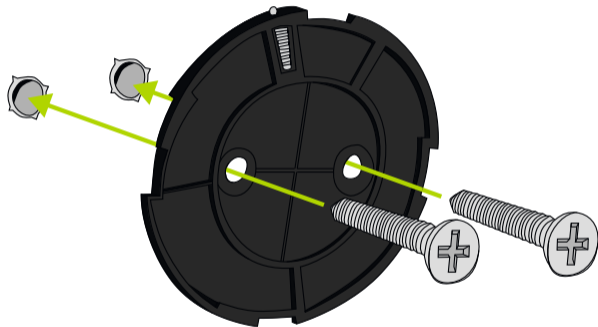
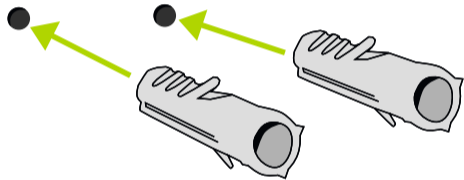

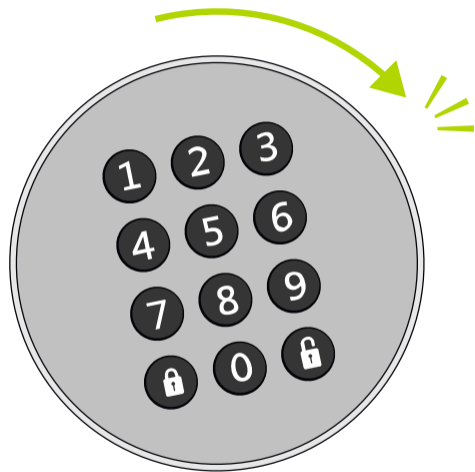

The following instructions are in english. Localized versions can be found with the QR-code below.



guide.danalog.com

Add the Danapad in the Danalock App

Open the Danalock App and add the Danapad by selecting "Add device" in the menu tab. When the Danapad has been enrolled you can pair it with your Danalock.

Go to: **Menu > Accessory devices > Danapad > Pairing**

and select the lock you want to control with the Danapad.



Set up pin codes for your Danapad

Go to: **Menu > Accessory devices > Danapad > Pin codes** and choose to add a new pin code.



Controlling the Danapad

The Danapad is ready to use when it has been paired with a Danalock or Universal Module and has been set up with one or more pin codes.



Locking: Press pin code followed by lock button. Success will respond with a single green blink.

Unlocking: Press pin code followed by unlock button. Success will respond with a single green blink.



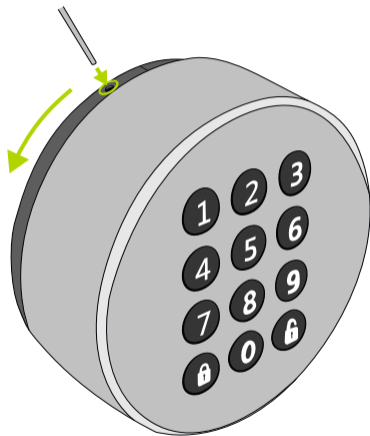

Dismounting



LED-Signals

The keypad indicates the status of several operations with different colors:



LED signal	LED color	Status indication
Single green blink		Performed operation successfully
Single red blink		Operation canceled or failed
Long green blink		Power on
Constant orange followed by green	 	Firmware is being updated

Operations

Operation	Input action	LED response
Turn on Danapad	Insert batteries	Display lights up green
Activate light only	press unlock button	Display lights up green
Clear input	Hold unlock button	Display blinks red once
Input timeout	Input clears after 10 sec with no input	Display blinks red once
Danapad lockout	5 invalid attempts causes a 2 min lockout	Display blinks red 3 times
Incorrect pin code length	The entered pin code is shorter than 4 digits or longer than 10 digits	Display blinks red once

Firmware upgrade

In the Danalock App navigate to your Danapad settings and select "Firmware" and then "Upgrade firmware". Make sure to keep your phone near the Danapad during the entire firmware upgrade process.

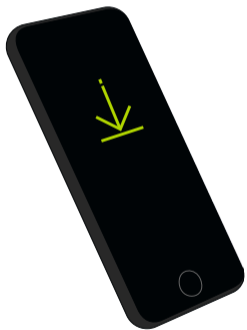

Danalock International ApS

Gammel Stillingvej 427C
8462 Harlev, DK

+45 4242 8122
info@danalock.com